

# UpDown

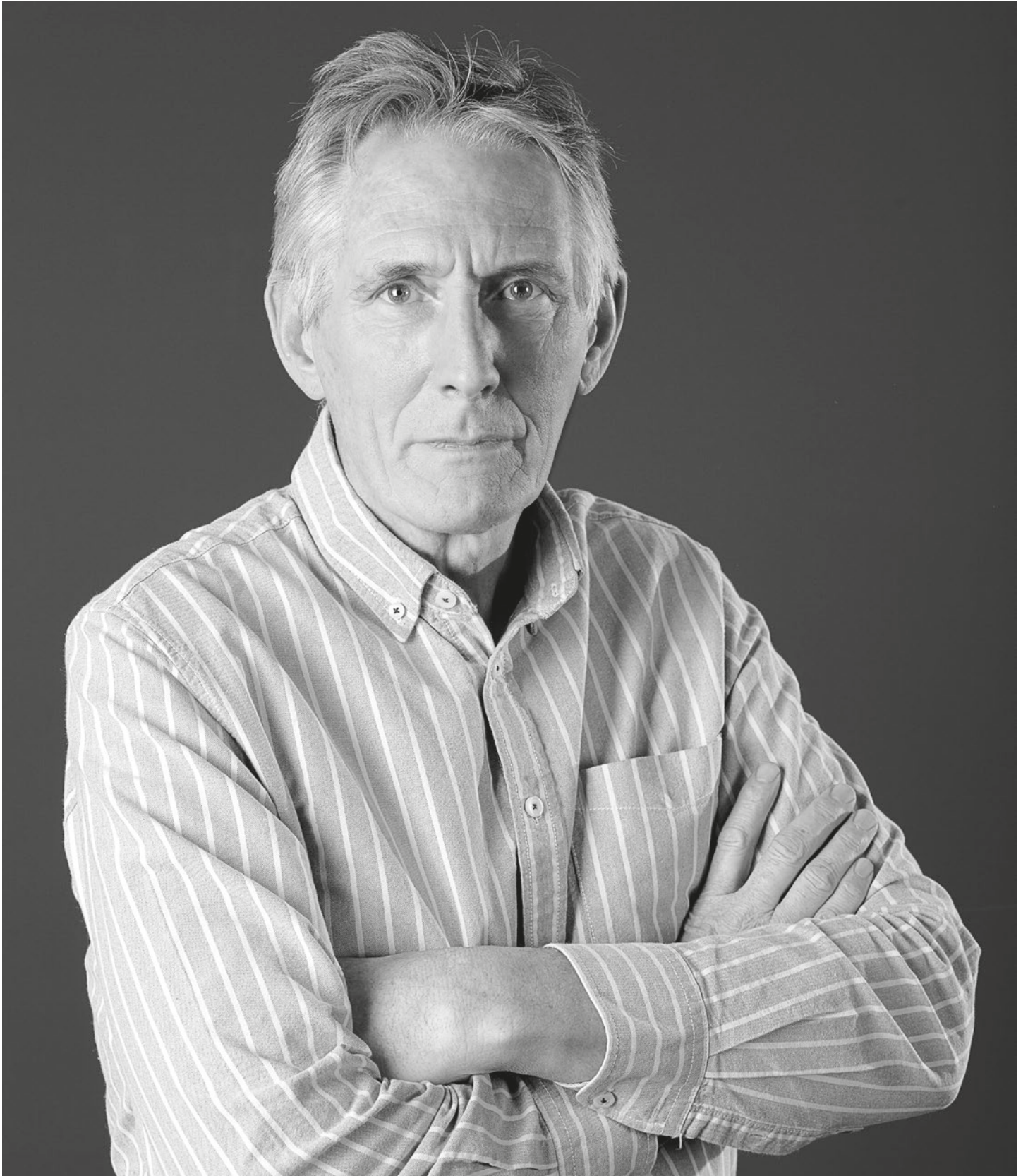

profim



UpDown explores not only the flexibility of the space where it is placed but also the visual elevation with its flowing and changing back giving it a unique and pleasing outcome. The taught and defined upholstery also sets off the most sophisticated, contemporary, retrospective and historical interior architecture. The construction and build execution will fulfil the most stringent needs of long term quality.

UpDown weiß, was das Geheimnis einzigartiger Räume ausmacht. UpDown bewirkt, dass jeder Raum plastisch und äußerst leicht wirkt. Eine deutliche Polsterung verleiht der Umgebung einen passenden Flair: einen raffinierten, modernen oder Retroflair. Die Ausführung der UpDown-Kollektion erfüllt selbst anspruchsvollste Bedürfnisse und sichert eine langjährige Qualität der Möbel.

A handwritten signature in black ink, reading "Hilary R. Birkbeck". The signature is fluid and cursive, with a period at the end.

**Hilary R. Birkbeck**  
Collection Designer





UpDown adapts to every place and emphasizes its individual style.

UpDown passt sich jedem Raum an und hebt seinen individuellen Stil hervor.







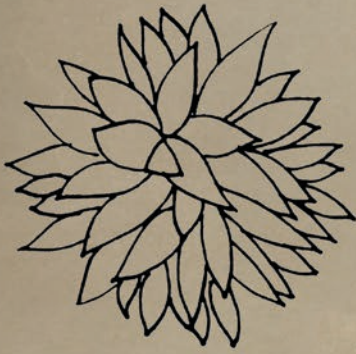

# ARRANGE IT

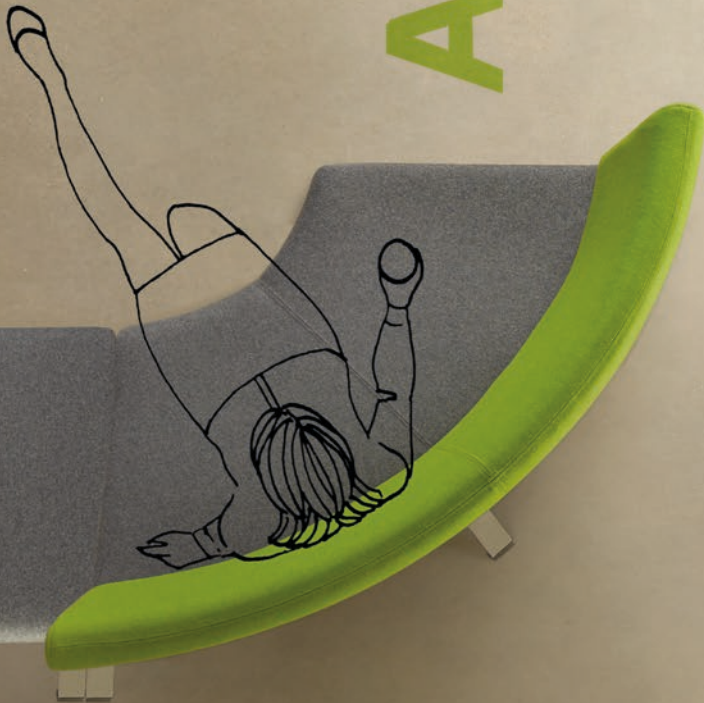

Spacious entrance hall in modern office buildings, patios, hotel lobbies, open spaces, shopping malls, reception desks, meeting venues... **What do these places have in common?**

Ob Foyers in modernen Bürogebäuden, Flure oder Hotelloobby, Hallen, Galerien, Rezeptionen, Treffpunkte....  
**Was haben diese Stellen gemeinsam?**



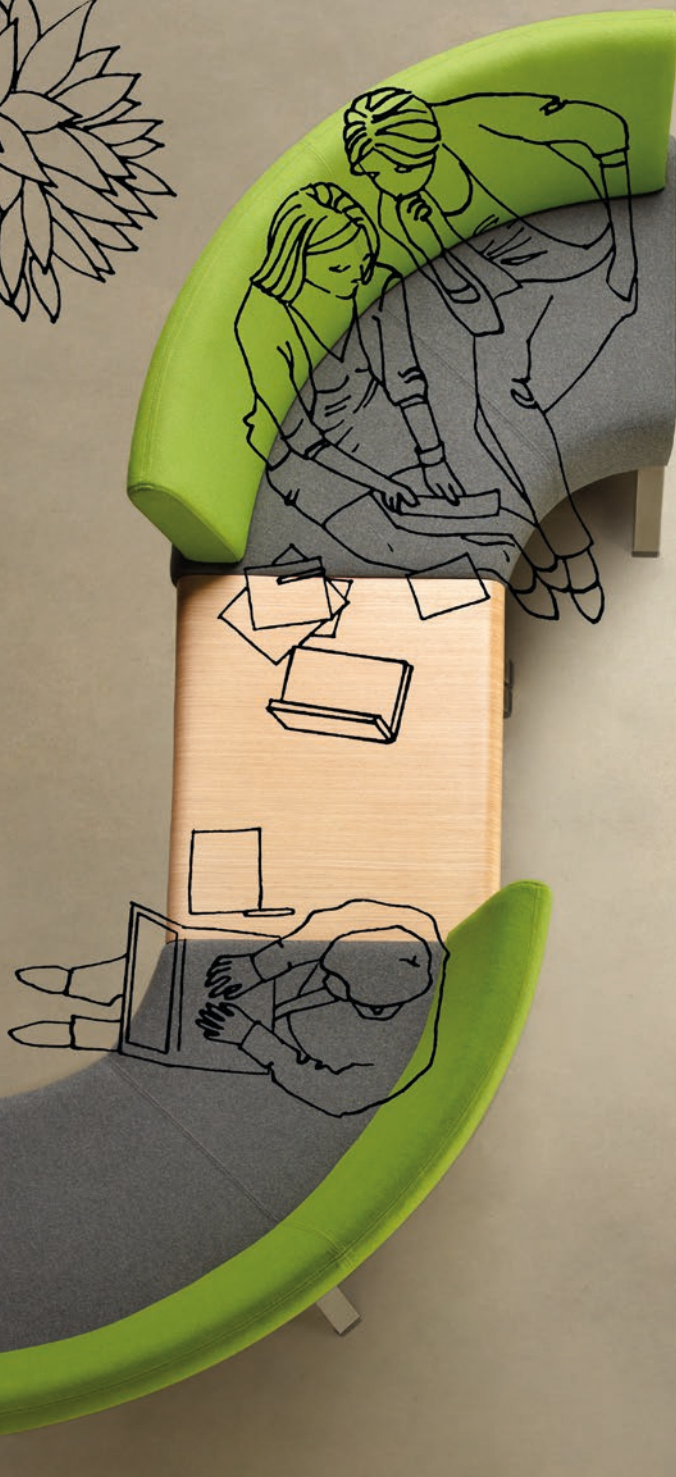

ARRANGE IT  
**AS YOU**





U



UpDown is an exceptional line of module furniture, designed for demanding spaces. Due to **free connection of elements**, it is easy to vivify the interior and create a place in which it is pleasant to stop for a while.

UpDown ist eine Kollektion einzigartiger Modulmöbel, die für anspruchsvolle Räume entworfen wurden. Durch eine beliebige Verbindung von Polstermodulen kann der Raum lebhafter gemacht werden und ein Platz geschaffen werden, in welchem man sich aufhalten kann.

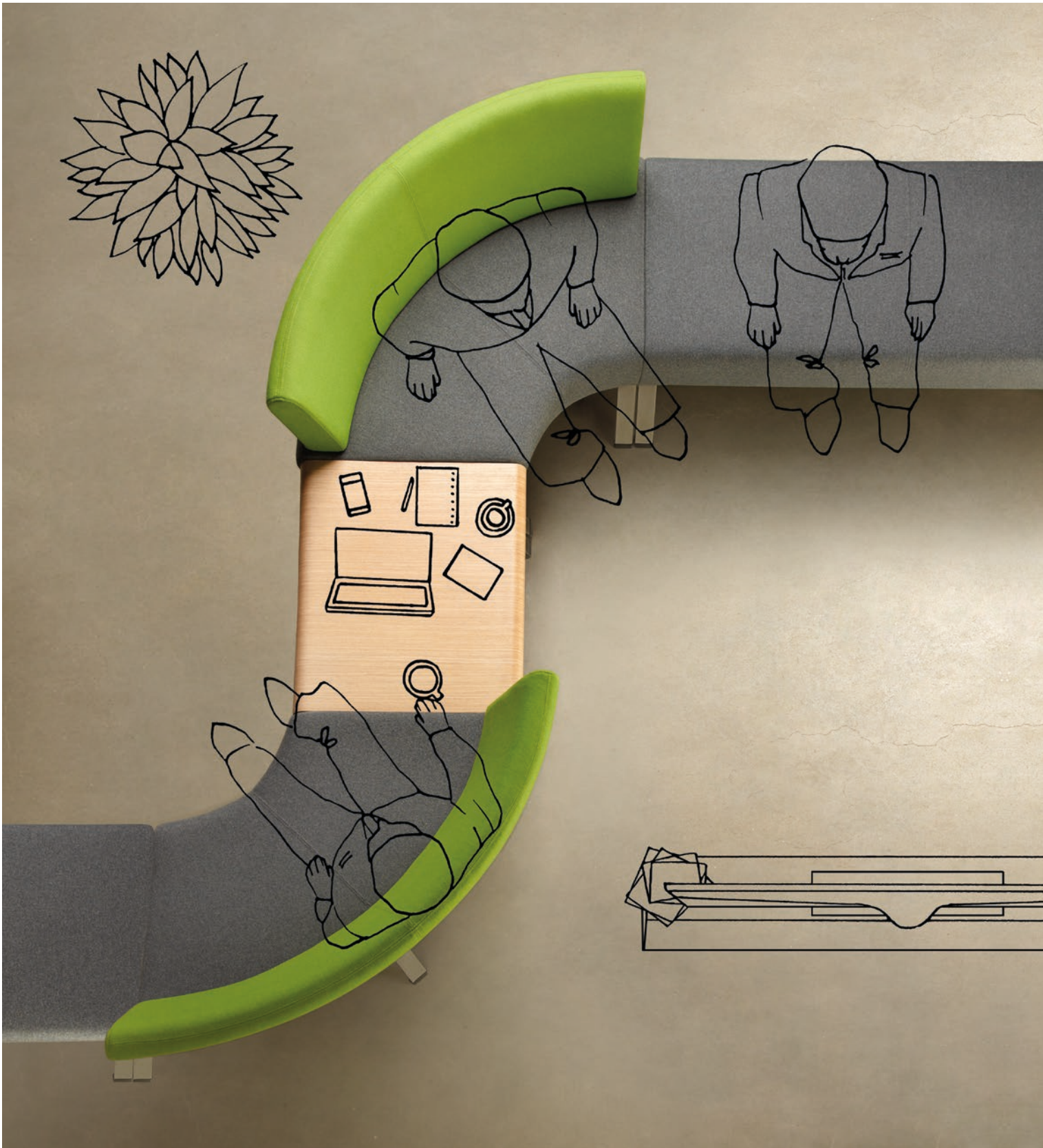



# ARRANGE IT AS YOU **LIKE**

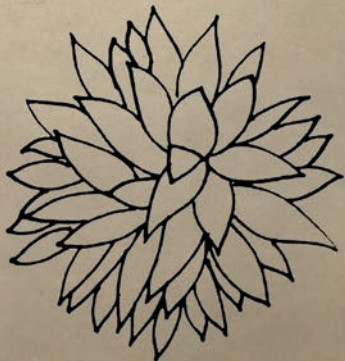
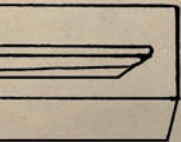
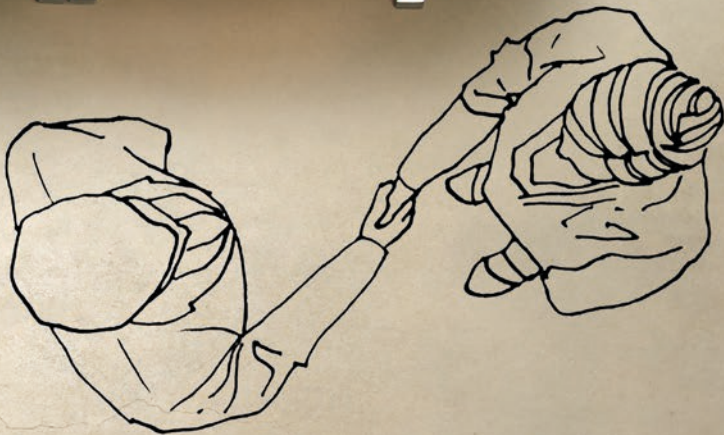

Complex set or a single module? In a straight line, in the shape of a swaying wave or a circle perimeter? Each of these options gives space **unique character**.

Eine UpDown Kombination oder UpDown-Einzelement? In Form einer geradem Linie, einer schwingenden Welle oder ein Kreis? Jede dieser Varianten verleihen einem Raum einen einzigartigen Charakter.



The line will work well in spaces that require **tailored solutions**. All seats are easily connectable. UpDown makes interior arrangement easier.

Diese Kollektion eignet sich für Räume, die spezielle Lösungen verlangen. Alle Sitzelemente können beliebig miteinander gekoppelt werden. Durch UpDown ist die Raumgestaltung einfacher.



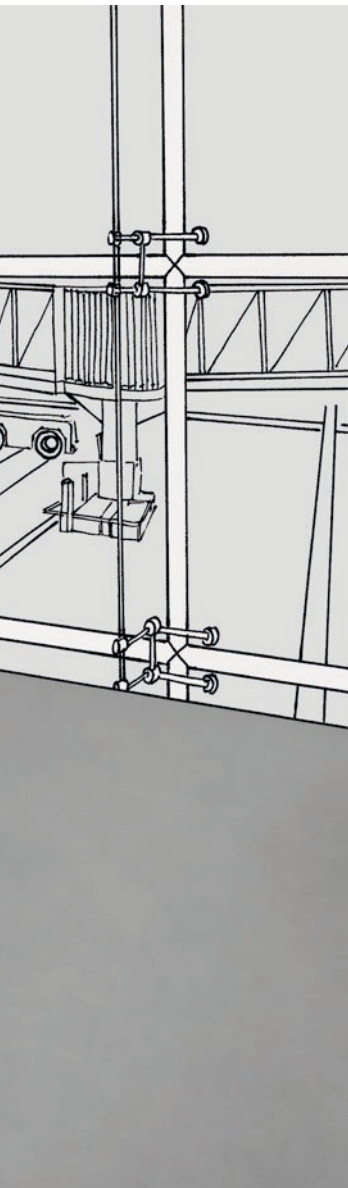

Streamline shapes stir the imagination and references to organic forms will be visible not only to a professional's eye. Possibilities of organizing any given space are countless.

Kreisförmige Kombinationen erwecken die Phantasie und die Verbindung mit organischen Formen sind unbegrenzt. Die Möglichkeit der Raumgestaltung ist vielseitig.





Possibility of creating individual arrangements makes that UpDown line **to give character not only to modern but also to traditional interiors.**





Die Möglichkeit der Schaffung individueller Raumgestaltungen bewirkt, dass UpDown nicht nur modernen, sondern auch klassischen Räumen einen einzigartigen Charakter verleiht.



## FLEXIBILITY

There are as many possibilities as there are ideas. Each seat can function separately and be the main item in an interior. The line is available **in over 100 colours of upholstery sewn in our own sewing room**. Thanks to the possibility of choosing various colours of seats and backs, as well as legs, one can create a unique set.

## ELASTIZITÄT

Es gibt so viele Möglichkeiten, wie wir Ideen haben. Jedes Modul kann separat stehen und ein Solitär sein. Die Kollektion ist in 100 Farben und in vielen Farbkombinationen erhältlich. Die Polsterung wird in unserer eigenen Näherei angefertigt. Durch die Möglichkeit der Sitzform, Armlehnen, sowie Gestellvarianten kann ein originelles Design geschaffen werden.



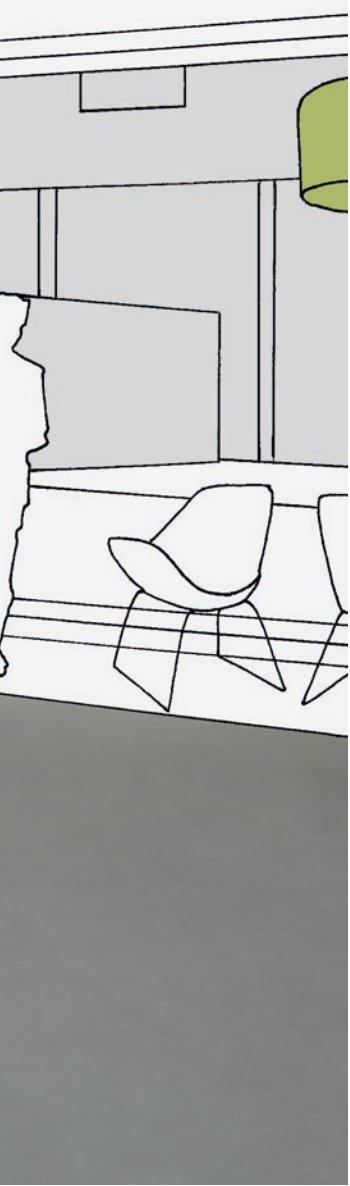

# COMFORT

Ergonomic seat, rounded rims, firm back... Due to properly matched parameters UpDown **meets the users' needs.**

## SITZKOMFORT

Ergonomische Sitze, abgerundete Kanten, robuste Armlehnen... Entsprechend ausgewählte Parameter bewirken, dass UpDown-Möbel den Bedürfnissen der Nutzer entsprechen.



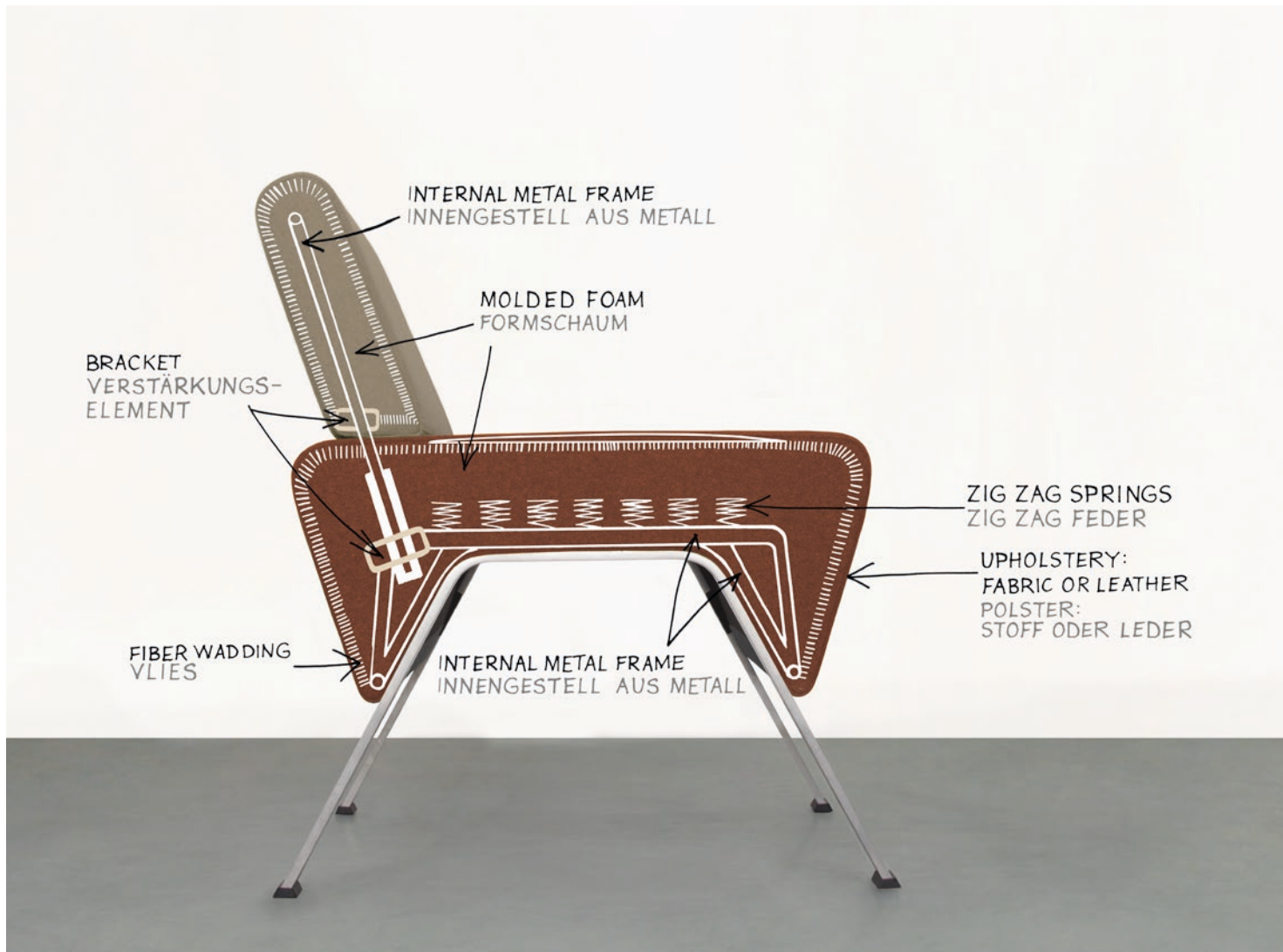

## QUALITY

Well-designed objects are made to last. While creating UpDown we used modern technologies, well-knit solutions and proved materials.

Internal metal frame ensures the right **durability**. Extra brackets secure areas most prone to exploitation. Springs hitched to the frame give the **feeling of comfort** and softness. Precisely selected parameters of seat and back foam make the furniture **exceptionally comfortable**. The wadding is responsible for correct position of the upholstery and gives it the **right shape**.

## QUALITÄT

Gut entworfene Gegenstände sind zeitresistent. Im UpDown benutzen wir moderne Technologien, durchdachte Lösungen und bewährte Stoffe. Eine Metallinnenstellage sorgt für eine entsprechende Robustheit.

Zusatzverstärkung sorgt für den Schutz für die am meisten benutzten Bestandteile. Die Feder werden an die Stellage montiert und sie geben das Komfort- und Geborgenheitsgefühl. Präzise gewählte Schaumparameter auf dem Sitz und der Lehne bewirken, dass Möbel äußerst bequem sind. Wattierungen sorgen für eine entsprechende Polsterungslage und verleihen der Polsterung eine angemessene Form.



# VALUES

UpDown seats are a great example of designer form and elaborate workmanship. Designing the line, we aimed at sustainable values. Thanks to that the set **delights with precise finishing, full reliability and affordable price.**

# WERTE

UpDown-Sitze sind das beste Beispiel der Designform und einer sorgfältigen Ausführung. Bei dem Kollektionsentwurf setzen wir auf feste Werte. Dadurch bezaubert unser Set durch eine präzise Verfeinerung, Verlässlichkeit und einen günstigen Preis.









# SAMPLE ARRANGEMENTS

Imagination is the limit.

## KOMBINATIONSMÖGLICHKEITEN

Nur die Phantasie könnte hier eine Beschränkung sein.

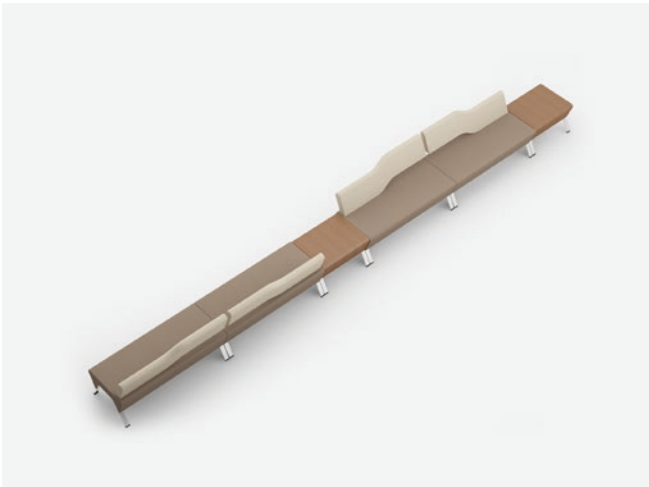



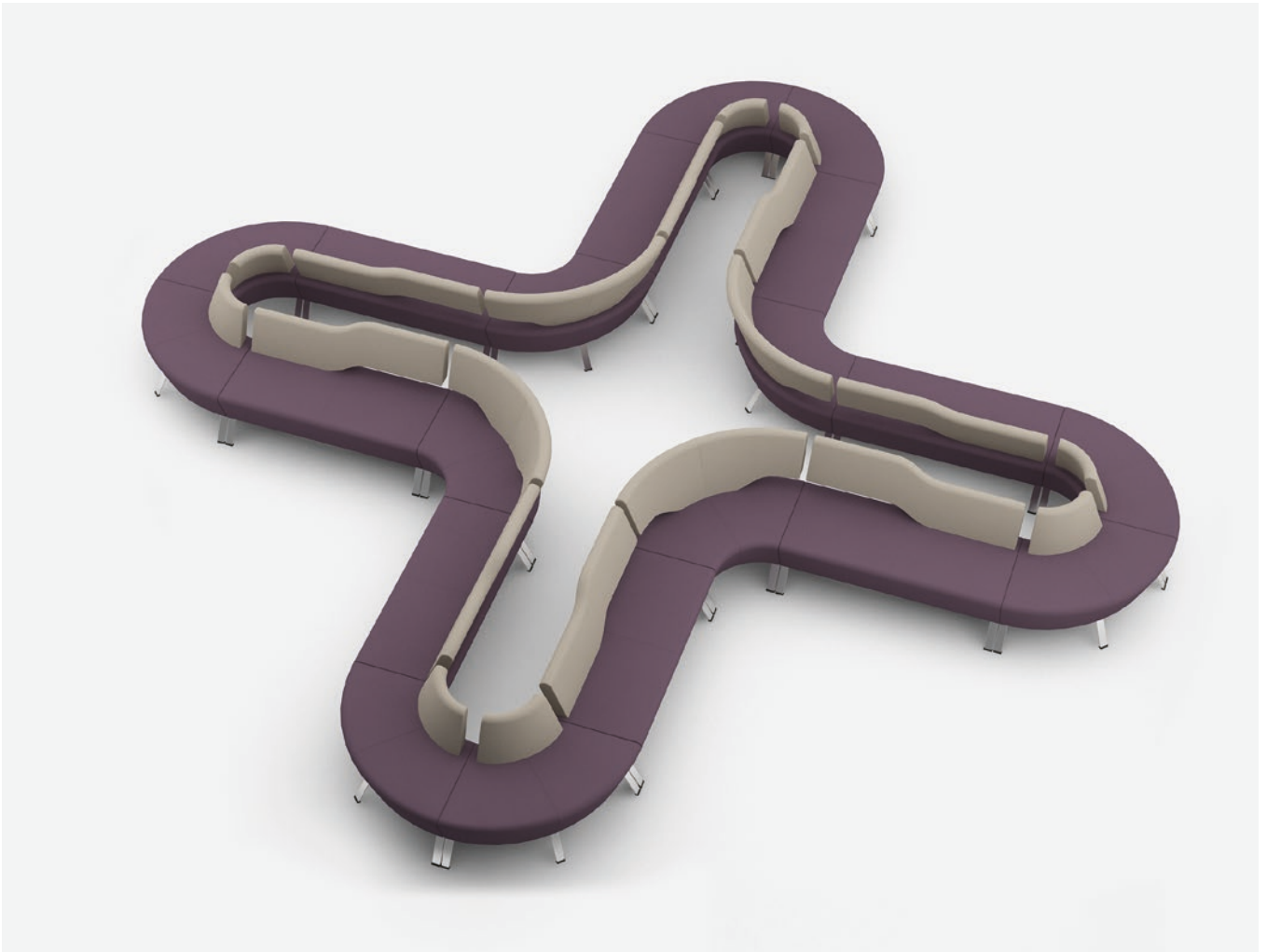
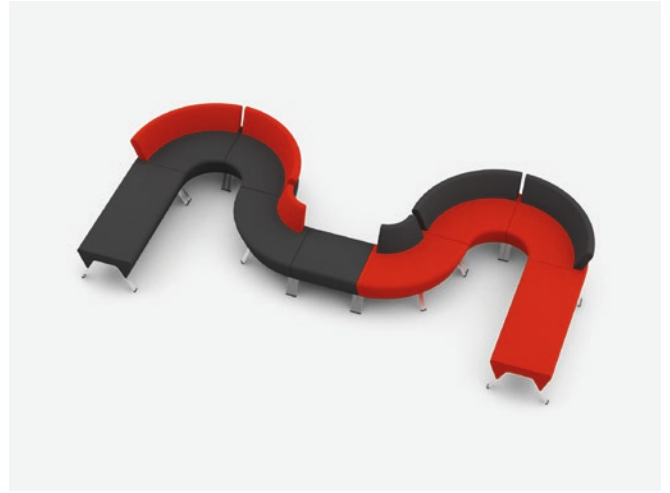

ELEMENTS IN THE COLLECTION

MODULELEMENTE

B10

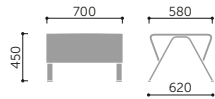

10

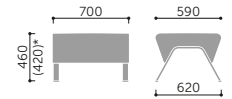

11

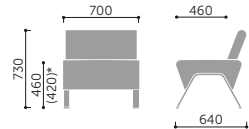

12

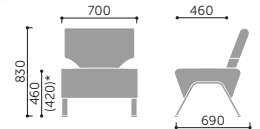

20

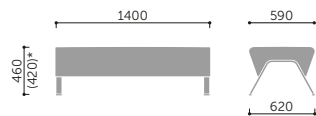

2R/2L

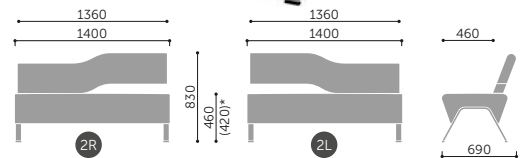



ELEMENTS IN THE COLLECTION

MODULELEMENTE

C10

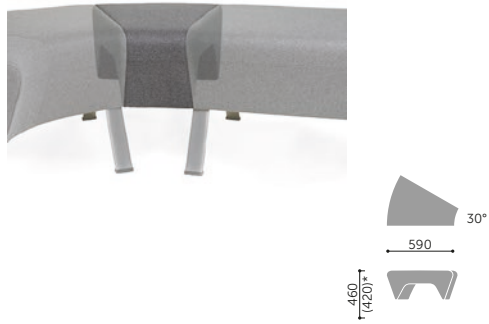

C20

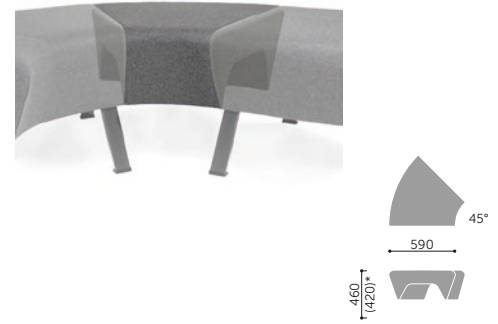

C40



C41



C42



C43



## FINISHING OPTIONS

### LEGS

#### FÜßE

Legs available in 2 options: metal in 4 colours and wooden (Beech plywood) finished in natural modified veneer in 5 colours.

Zwei Gestelle:

- Metallgestell in 4 Farben
- Holzgestell (Schichtholz) in 5 Edelfurnier-Farben

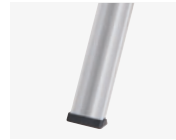

chrome  
chrom



satin  
satin



black  
schwarz



metallic  
weissalu



wood  
wood



Teflon glides (only in metal legs)  
Teflingleitern nur beim Metallgestell



Felt glides (metal and wooden legs)  
Filzgleiter beim Metall- und Holzgestell

### TABLE TOP

#### TISCHPLATTE

Beech table tops available in natural modified veneer in 5 colours.

Tischplatte aus Edelfurnier in 5 Farben.

Natural modified veneer | Edelfurnier



HM10  
bleached oak  
Eiche hell



HM11  
classic oak  
Eiche classic

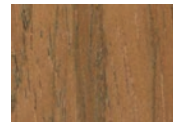

HM12  
cardinal oak  
Eiche cardinal



HM30  
teak  
Teak

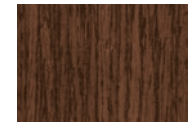

HM20  
wenge classic  
Wenge classic

### FABRIC OR LEATHER

#### POLSTER

The collection is available in over 100 colours, in 10 different finishes upholstery (Next, Medley, Sofline, Sprint, Valencia, Xtreme, Fame, Step, Ultima, Leather).

Stoffkollektion in 11 verschiedenen Stoffbezügen- Next, Medley, Softline, Sprint, Valencia, Xtreme, Fame, Step, Ultima, Leder, Leder Premium in 100 verschiedenen Polsterfarben.

Upholstery samples | Beispielpolsterbezüge

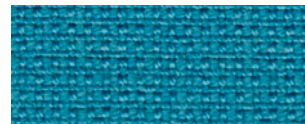

### LINKING PARTS

#### REIHENVERBINDER

To stabilize adjoining elements.  
Zur Verbindung von 2 Elementen.

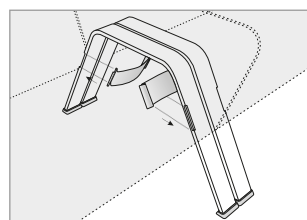



Please use codes at order | Bitte die Codes bei der Bestellung verwenden

**UpDown**

---

**Element type | Elementtyp**

1-seat bench 1-er Sitzbank ohne Rückenlehne	10
1-seat bench, low backrest 1-er Sitzbank, Rückenlehne niedrig	11
1-seat bench, high backrest 1-er Sitzbank, Rückenlehne hoch	12
2-seat bench 2-er Sitzbank ohne Rückenlehne	20
2-seat bench, backrest fixed on the right side 2-er Sitzbank, Rückenlehne rechts befestigt	2R
2-seat bench, backrest fixed on the left side 2-er Sitzbank, Rückenlehne links befestigt	2L
30 degree connector Verbindungselement 30°	C10
45 degree connector Verbindungselement 45°	C20
90 degree connector Verbindungselement 90°	C40
90 degree inner connector, low backrest Verbindungselement 90°, Rückenlehne niedrig	C41
90 degree outer connector, high backrest Verbindungselement 90°, Rückenlehne hoch	C42
90 degree outer connector, low backrest Verbindungselement 90°, Rückenlehne niedrig	C43
table, 700x450x620 mm Tish, 700x450x620 mm	B10

**Table top colour**

---

**Upholstery colour\*\* | Polsterfarbe\*\***

**Farben von Tischplatte**

---

**Gestellfarbe**

metal legs:   Metallgestell:	wooden legs:   Holzgestell:
black   schwarz	wood   wood
metallic   weissalu	
chrome   chrom	
satin   satin	

\* Seat height measured according to PN EN 16139 norm (with seat burden).  
The measurements are approximate and can differ depending on the product configuration. Measuring methodology is available at this link: [www.profim.eu/Measuring\\_methodology.pdf](http://www.profim.eu/Measuring_methodology.pdf)  
Die Sitzhöhe nach PN EN 16139 (mit Belastung) gemessen.  
Die Abmessungen dienen zur Orientierung und können sich abhängig von der ausgewählten Konfiguration des Produktes unterscheiden.  
Messmethode unter dem Link: [www.profim.de/Messmethode\\_fur\\_die\\_Katalogmasse.pdf](http://www.profim.de/Messmethode_fur_die_Katalogmasse.pdf)

\*\* Option of mixing colours of the same fabric on seat and backrest according to below scheme: A – seat, B – backrest. In case of order of such option, following example should be specified: ST-5/ST-6 (where ST-5 – A, ST-6 – B).  
Es gibt eine Möglichkeit, UpDown ohne Mehrpreis zweifarbig zu bestellen: A – Sitz, B – Rückenlehne.  
z.B. ST-5/ST-6 (ST-5 – A, ST-6 – B).

[www.profim.eu](http://www.profim.eu)

The producer reserves the right to conduct construction changes and improvements of the products.  
Colours presented in the catalogue may vary from the original colours of furniture.

Wir behalten uns Änderungen der Produkte im Sinne einer technischen Weiterentwicklung oder Änderungen in Form  
und Farbe vor. Die Farben, die im Katalog zu sehen sind, können von faktischen Farben abweichen.



**CHROMIUM (III)**  
Eco-Friendly Technology

**CHROM (III)**  
Umweltfreundliche  
Technologie

